

M12 MALE 90° / M12 FEMALE 90°

PVC 3X0.34 GRAY, UL/CSA 0.3m

90° – 90°

M12 – M12, 3

7005 - M12 Lite -

[Link to Product](#)

Illustration

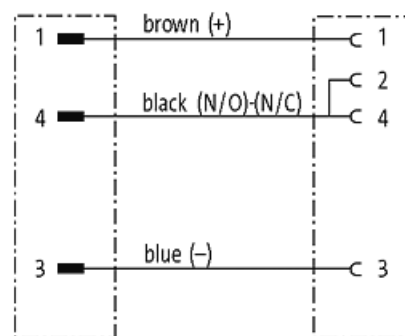
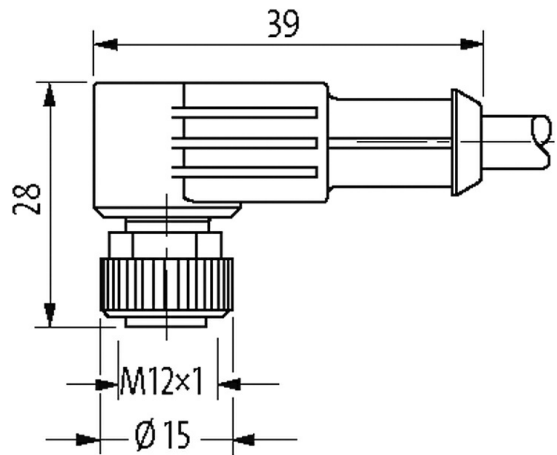
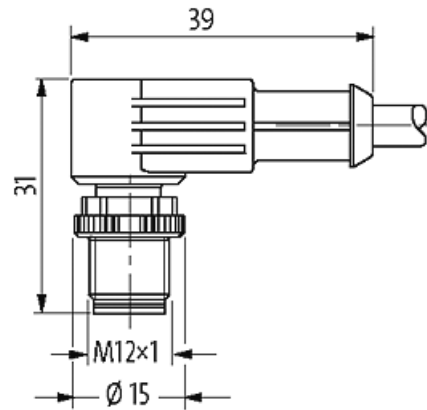
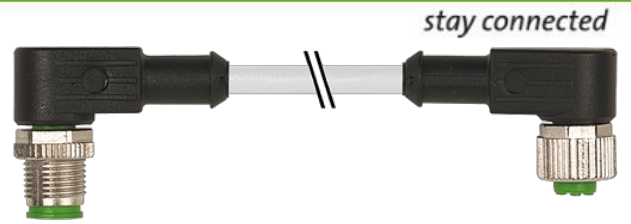

Male

Female



Product may differ from Image

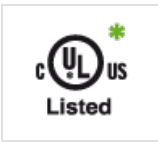

* UL/CSA

Form	
Form	40301
/	3× 0.34 mm ²
	PVC (, ,)
	PVC (UL/CSA)
	4.6 mm ±5%
	10×
	-30...+80 °C
	-5...+80 °C
	213
	1 (PVC)
()	UL (AWM-Style 2464/1731), CSA
[g/m]	34,10
()	max. 60 Ω/km (20 °C)
()	0.15 mm
()	19× 0.15 mm (5)
	3× 0.34 mm ²
AWG	AWG 22
	PVC
	CFC
	45 ±5 D
	1.25 mm ±5%
/	
	3
	no
	PVC
)	CFC
Shore hardness (jacket)	85 ±5 A
()	4.6 mm ±5%
()	
	UL 300 V AC
	2000 V AC
	DIN VDE 0298-4
	-30...+80 °C
	-5...+80 °C
	5×
	10×
	max. 250 V AC/DC
UL listed	max. 30 V AC/DC

	max. 4 A
	IEC 60664-1, category I
	A
	(M12×1 mm) 0.6 Nm
	M12 (SW13)
	IP66K, IP67 EN 60529
	,
	PUR
()	10 mm
	DIN EN 61076-2-101 (M12)
	3
	-25 +85 ,
eClass	27061801
HS	85444290
Packaging unit	1
	DE