

M12 MALE 90° / M12 FEMALE 90°

PVC 5X0.34 black 1m

90° – 90°

M12 – M12,5

7005 - M12 Lite -

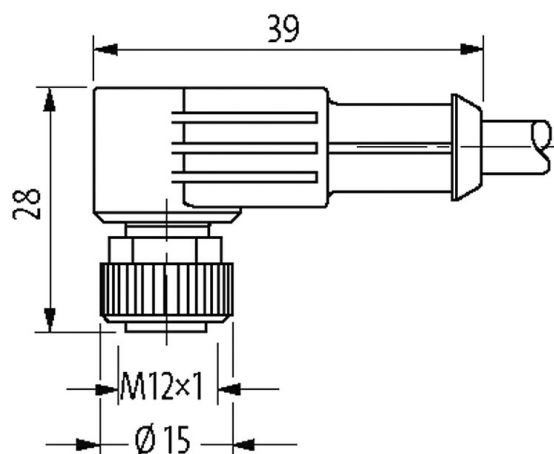
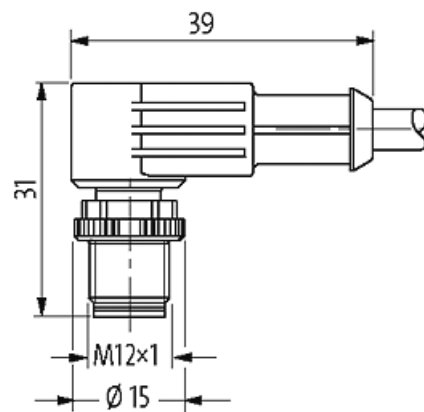
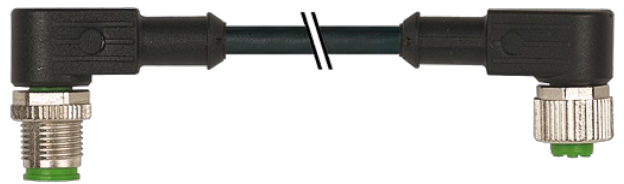
[Link to Product](#)**Illustration**

1	brown (+)	C 1
2	white (N/C)	C 2
4	black (N/O)	C 4

stay connected

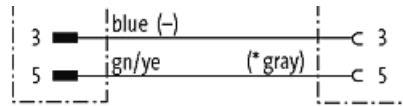

(* for cable type 126, 732, 219, 619)

Male

Female

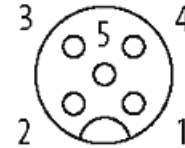
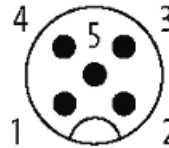

Product may differ from Image



* UL/CSA

Form

Form	40285
	729
/	5 x 0.34 mm ²
	PVC (, , , ,)
	PVC
	5.9 mm ±5%
	10x
	-30...+80 °C
	-5...+70 °C
	729
()	CE conform
[g/m]	59,51
()	max. 57 Ω/km (20 °C)
()	0.15 mm
()	19 x 0.15 mm (5)
	5 x 0.34 mm ²
AWG	AWG 22
	PVC
/	
	5
	no
	PVC
()	5.9 mm ±5%
()	
	300/500 V AC
	2000 V AC

	-30...+70 °C
	-5...+70 °C
	10×
	max. 125 V AC/DC
UL listed	max. 30 V AC/DC
	1.5 kV
	max. 4 A
	IEC 60664-1, category I
	5
	A
LED	no
	(M12×1 mm) 0.6 Nm
	M12 (SW13)
	IP65, IP66K, IP67 EN 60529
	,
	PUR
()	10 mm
	DIN EN 61076-2-101 (M12)
	3
	-25 +85 ,
HS	85444290
Packaging unit	1
	DE