

MEF EMC-FILTER 1-PHASE 2-STAGE

I:4A U:250 VAC/300 VDC snap on

4 A

[Link to Product](#)

Illustration

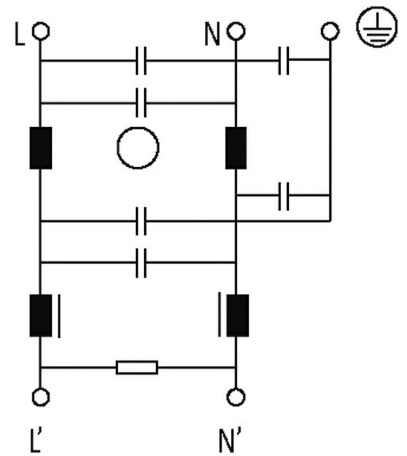
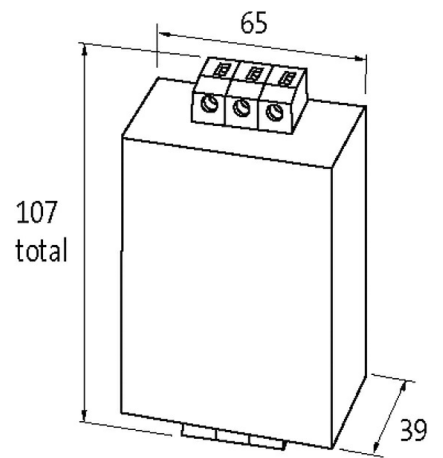

Product may differ from Image



max. 250 V AC/300 V DC

50...60 Hz

max. 5 mA (250 V AC)

The information in this brochure has been compiled with the utmost care.

Liability for the correctness completeness and topicality of the information is restricted to gross negligence. Version: 01/20

Murrelektronik GmbH | Falkenstraße 3 | 71570 Oppenweiler | Fon +49 (71 91) 47-0 | Fax +49 (71 91) 47-491000 | shop@murrelektronik.com | shop.murrelektronik.com

	18× IN t ≤ 0.5 ms; 1.5× IN t ≤ 1 min. (1×)
	0.2 6 mm ² (AWG 24 9); 0.2 4 mm ² AWG 24 11
	25/085/21 (EN 60068-1)
	2.7 kV (L - N), 2 s; 2.1 kV (L - L), 2 s (EN 60939-2)
	DIN TH35 EN 60715
H×W×D	107×65×39 mm
	2- EMC MEF 1/2 0.1 30 MHz 10
EAN	4048879029353
eClass	27130806
HS	85363010
Packaging unit	1
	IT