

MSUD DOUBLE VALVE PLUG FORM BI 11MM

PUR 4X0.75 black UL/CSA, drag ch 7.5m

MSUD
Form BI (11 mm)
24 V AC ±20% / DC ±25%
LED, Suppression
L=150 mm

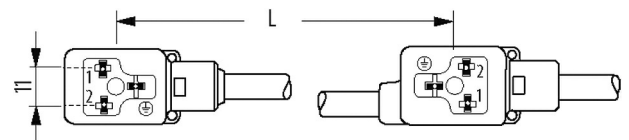
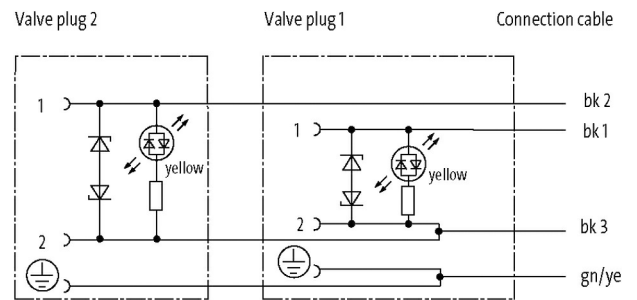
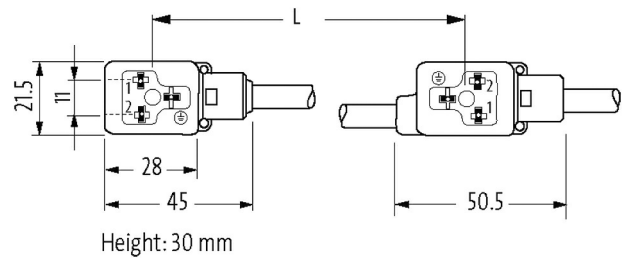
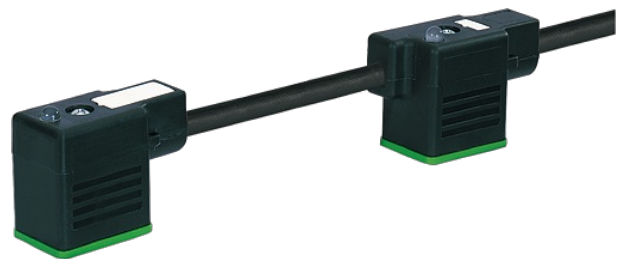

cCSAus

* UL/CSA

58121

/	4 × 0.75 mm ²
	PP (, /)
C-track	10 Mio.
	PUR (UL/CSA)
	6.5 mm ±5%
()	10 × Ø
()	-40...+80 °C
()	-25...+80 °C
	637
	3 (PUR)
()	cRUus (AWM-Style 20549/10493); CE conform
[G/m]	69,30
(wire)	,
()	max. 26 Ω/km (20 °C)
-Ø	0.15 mm
()	42 × 0.15 mm (6)
()	4 × 0.75 mm ²
AWG	AWG 18
()	PP
()	CFC, , , ,
()	70 ±5 D
-Ø	1.85 mm ±5%
/	, , /
	4
(shielded)	no
	PUR
()	CFC, , , , , , , , , , ,
()	90 ±5 A
-Ø ()	6.5 mm ±5%
()	, , (EN 60811-404)
	300 V AC
	2500 V AC
	DIN VDE 0298-4
()	-40...+80 °C, (+90 °C 10 000)
()	-25...+80 °C, (+90 °C 10 000)
()	5 × Ø
()	10 × Ø
(C-track)	max. 10 Mio. (25 °C)
(C-track)	max. 3 m/s
(C-track)	max. 10 m/s ²
	±180°/m
	max. 2 Mio. (25 °C)
	35
	24 V AC ±20% / DC ±25%
	max. 4 A

	max. 55 V
	max. 20 ms
LED	()
	12 mA
	()
	M3 (0.4Nm)
	IP67 - (EN 60529)
	0.8 kV
	-25...+85 °C ()
eClass	27061801
	85444290
	CZ
	1