

M12 male 90° / M12 female 90°

PUR 3x0.34 bk UL/CSA 2m

Male 90° – female 90°

M12 – M12, 3

Art-No. 7005 -M12 Lite (,) .

stay connected

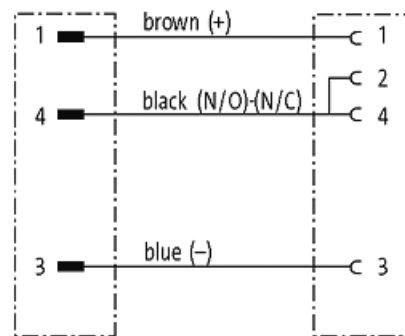
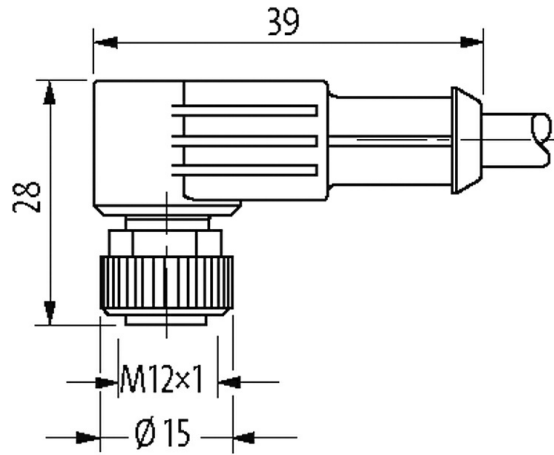
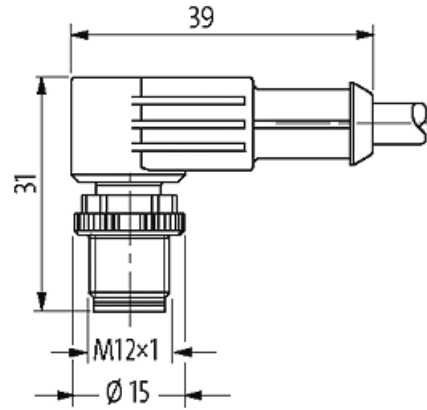
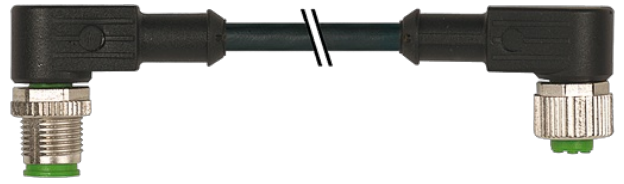

Male

Female

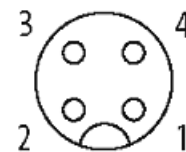
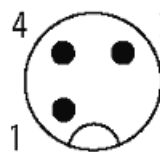

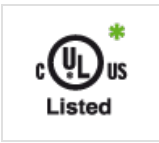

* UL/CSA

40301

/	3 × 0.34 mm ²
	PVC (, ,)
C-track	2 Mio.
	PUR/PVC (UL/CSA)
	4.9 mm ±5%
()	15 × Ø
()	-30...+80 °C
()	-5...+80 °C
	623
	2 (PUR/PVC)
()	UL (AWM-Style 20549/1731), CSA; CE conform
[G/m]	35,97
(wire)	,
()	max. 57 Ω/km (20 °C)
-Ø	0.1 mm
()	42 × 0.1 mm (6)
()	3 × 0.34 mm ²
AWG	AWG 22
()	PVC
()	CFC, , , ,
()	43 ±5 D
-Ø	1.25 mm ±5%
/	RAL 9005
	3
(shielded)	no
	PUR/PVC
()	CFC, , , , , , , , ,
()	80 ±5 A (PVC-); 85 ±5 A (PUR-)
-Ø ()	4.9 mm ±5%
()	,
	UL 300 V AC
	2000 V AC
	DIN VDE 0298-4
()	-30...+80 °C
()	-5...+80 °C
()	10 × Ø
()	15 × Ø
(C-track)	max. 2 Mio. (25 °C)
(C-Track)	max. 5 m (horizontal)
(C-track)	max. 3.3 m/s
(C-track)	max. 5 m/s ²

	max. 250 V AC/DC
(UL)	max. 30 V AC/DC
	max. 4 A
	IEC 60664-1, category I
	A-coded
	(M12×1 mm) 0.6 Nm ,
	M12 (SW13)
	IP66K, IP67 (EN 60529)
Locking	,
	PUR
(-Ø)	10 mm
	DIN EN 61076-2-101 (M12)
	3
	-25...+85 °C ()
eClass	27061801
	85444290
	DE
	1