

M12 MALE 90° / M12 FEMALE 90°

PUR 5X0.34 black UL/CSA 0.6m

Male 90° – female 90°

M12 – M12, 5

Art-No. 7005 -M12 Lite (,) .

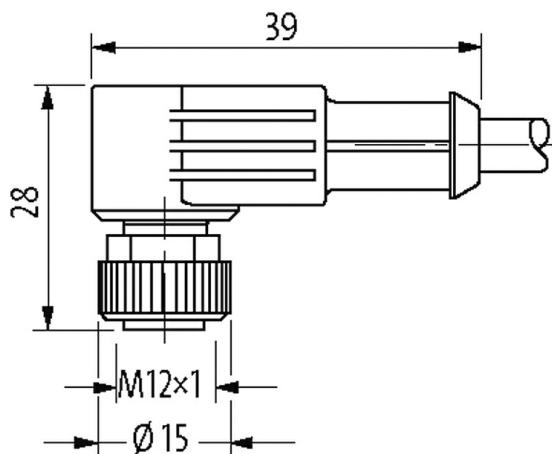
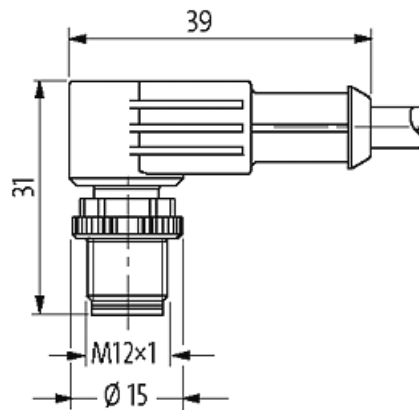
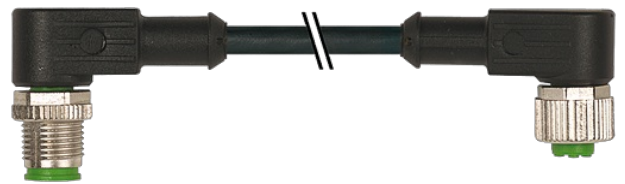

1	brown (+)	c 1
2	white (N/C)	c 2
4	black (N/O)	c 4

stay connected

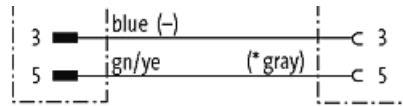

(* for cable type 126, 732, 219, 619)

Male

Female

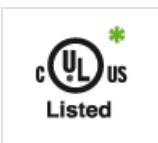
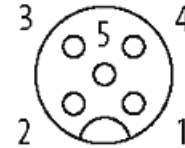
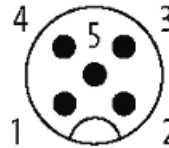

* UL/CSA

40285

/	5x 0.34 mm ²
	PP (, , ,)
C-track	10 Mio.
	PUR (UL/CSA)
	4.8 mm ±5%
()	10x Ø
()	-40...+80 °C
()	-25...+80 °C
	732
	3 (PUR)
()	cRUus (AWM-Style 20549/10493); CE conform
[G/m]	41,80
(wire)	,
()	max. 57 Ω/km (20 °C)
-Ø	0.1 mm
()	42x 0.1 mm (6)
()	5x 0.34 mm ²
AWG	AWG 22
()	PP
()	CFC, , , ,
()	70 ±5 D
-Ø	1.25 mm ±5%
/	, , , ,
	5
(shielded)	no
	PUR
()	CFC, , , , , , , , , ,
()	90 ±5 A

-Ø ()	4.8 mm ±5%
()	
	, , (EN 60811-404)
	300 V AC
	2500 V AC
	DIN VDE 0298-4
()	-40...+80 °C, (+90 °C 10 000)
()	-25...+80 °C, (+90 °C 10 000)
()	5× Ø
()	10× Ø
(C-track)	max. 10 Mio. (25 °C)
(C-track)	max. 3 m/s
(C-track)	max. 10 m/s ²
	±180°/m
	max. 2 Mio. (25 °C)
	35
	max. 125 V AC/DC
(UL)	max. 30 V AC/DC
	1.5 kV
	max. 4 A
	IEC 60664-1, category I
	5
	A-coded
LED	no
	(M12×1 mm) 0.6 Nm ,
	M12 (SW13)
	IP65, IP66K, IP67 (EN 60529)
Locking	,
	PUR
(-Ø)	10 mm
	DIN EN 61076-2-101 (M12)
	3
	-25...+85 °C ()
	85444290
	DE
	1