

MEF EMC-FILTER 1-PHASE 2-STAGE

I:6A U:250 VAC/300 VDC snap on

: 6 A
DIN

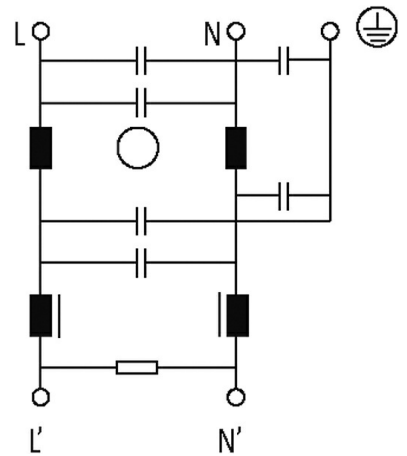
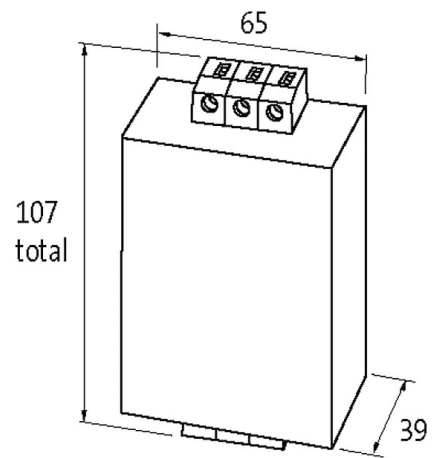

max. 250 V AC/300 V DC

50...60 Hz

max. 5 mA (250 V AC)

18× (IN t) max. 0.5 ms; 1.5× (IN t) max. 1 min. (1× per hour)

0.2...6 mm² (AWG 24...9); 0.2...4 mm² (AWG 24...11)

25/085/21 (EN 60068-1)

() 2.7 kV (L - N), 2 s; 2.1 kV (L - L), 2 s (EN 60939-2)

;

DIN TH35 (EN 60715)

H×W×D 107×65×39 mm

2 stage EMC MEF 1/2 0.1...30MHz (<10cm).MC ,

: - SMPS, , ,

EAN 4048879029346

eClass 27130806

85363010

IT

1