

SIEMENS CONTACTOR SUPPRESSOR

RC, 110VAC/DC

Art.No.: 21201

Weight: 0.008 kg

Country of origin: DE

Model designation: RC 48-127 V-S00

110 V AC/DC

RC

Link to Product

Illustration

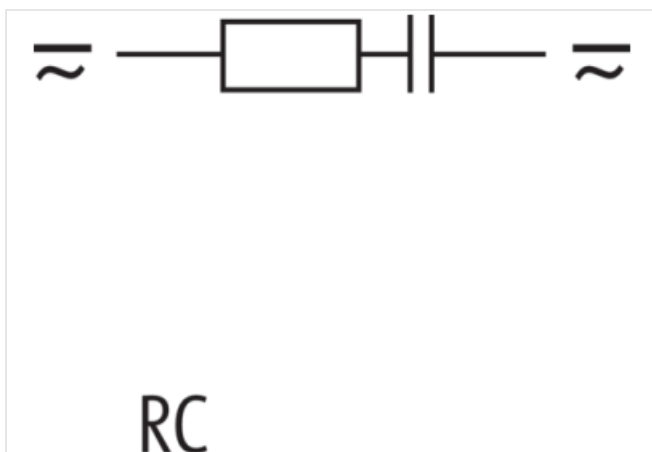
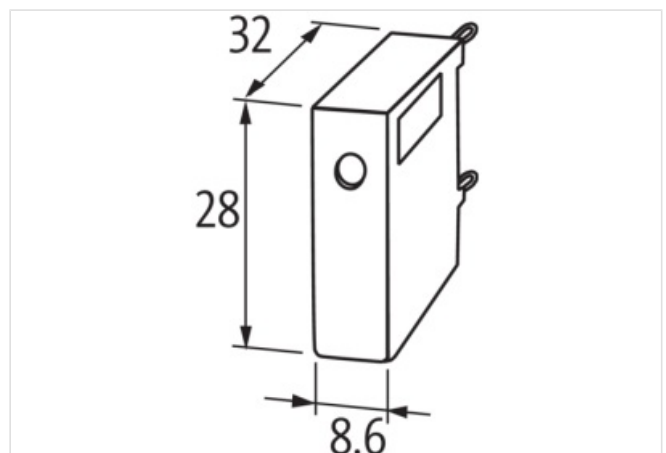

Product may differ from Image



Commercial data

Material short text	RC 48-127 V-S00
URL Webshop	https://shop.murrelektronik.com/21201
GTIN	4048879019989
ECLASS-6.0	27371013

ECLASS-6.1	27371013
ECLASS-7.0	27371013
ECLASS-7.1	27371013
ECLASS-8.0	27371013
ECLASS-8.1	27371013
ECLASS-9.0	27371013
ECLASS-9.1	27371013
ECLASS-10.0.1	27371013
ECLASS-10.1	27371013
ECLASS-11.0	27371013
ECLASS-11.1	27371013
ECLASS-12.0	27371013
ECLASS-13.0	27371013
ECLASS-14.0	27371013
ETIM-5.0	EC002498
ETIM-6.0	EC002498
ETIM-7.0	EC002498
ETIM-8.0	EC002498
customs tariff number	85363010
EAN	4048879019989
Packaging unit	1

Electrical data | Input

Input voltage AC min.	24 V
Input voltage AC max.	127 V
Input voltage DC min.	24 V
Input voltage DC max.	127 V

Mechanical data | Mounting data

Height	28 mm
Width	8,6 mm
Depth	32 mm