

## MOTOR SUPPRESSOR

Varistor, 3x400VAC/4kW

3× 400 V AC

VDR

For DIN-rail mounting use 2×Art.-No. 20900 adapter feet

Suppressors for other voltages, frequencies, and motor ratings available on request. Do not use RC motor suppressors with frequency inverters.

### [Link to Product](#)

Illustration

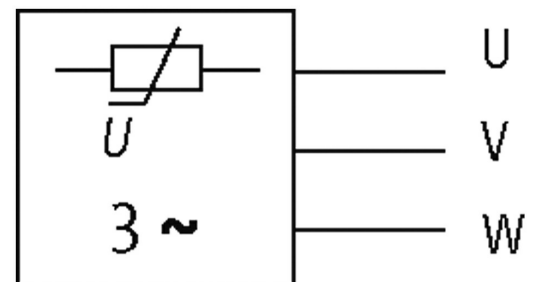
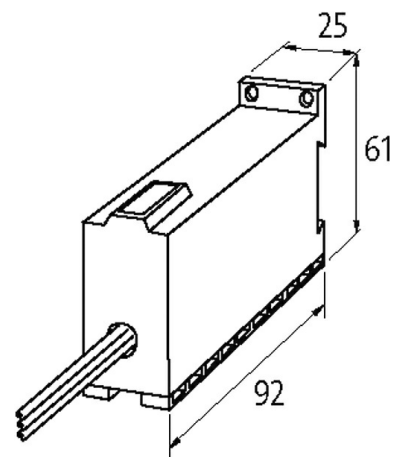

VDR

Product may differ from Image

**Technical Data**

Frequency	10...400 Hz
Material	Flame retardant plastic acc. to (UL 94)
Potting compound	2-component epoxy

**General data**

Connection	approx. 500 mm, single cores 1 mm <sup>2</sup>
Mounting method	DIN-rail mountable TH35 (EN 60715)
Temperature range	-20...+60 °C

The information in this brochure has been compiled with the utmost care.  
Liability for the correctness completeness and topicality of the information is restricted to gross negligence. Version: 05/21

Dimensions H×W×D 92×61×25 mm

**Commercial data**

country of origin	CZ
customs tariff number	85363010
EAN	4048879019385
eClass	27371013
Packaging unit	1