

## RJ45 male 0° shielded with cable, Gigabit

TPE 4x2x24AWG SF/UTP CAT5e bu UL/CSA, CM 25m

Ethernet CAT5e

Male straight

RJ45, 8-pole

shielded

without cable sleeves

Protection cap

Further cable lengths on request.

Plastic housings with good resistance against chemicals and oils.

The resistance to aggressive media should be individually tested for your application. Further details on request.

### [Link to Product](#)

#### Illustration

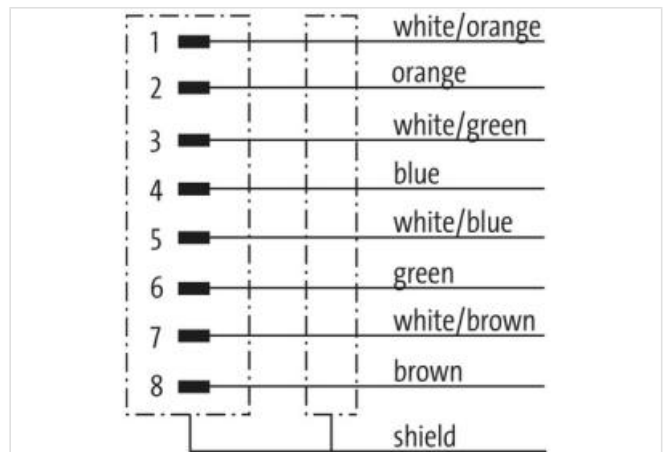

Product may differ from Image

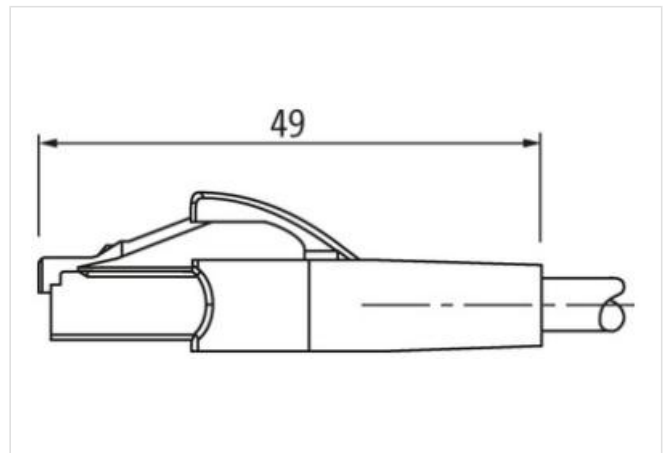

Cable length

25 m

Side 1	
Mounting method	inserted
Family construction form	RJ45
No. of poles	8
取引条件	
ECLASS-6.0	27061801
ECLASS-6.1	27060307
ECLASS-7.0	27060307
ECLASS-8.0	27060307
ECLASS-9.0	27060307
ECLASS-10.1	27060307
ECLASS-11.1	27060307
ECLASS-12.0	27060307
ETIM-5.0	EC002599
GTIN	4048879892421
HSコード	85444210
Packaging unit	1
Electrical data   Supply	
Operating voltage DC max.	60 V
Operating voltage DC max. (UL-listed)	30 V
Current operating per contact max.	1,5 A
Industrial communication	
Transfer parameters	CAT5e
Diagnostics	
Status indication LED	no
Device protection   Electrical	
Degree of protection (EN IEC 60529)	IP20
Additional condition protection degree	inserted, screwed
Pollution Degree	3
Mechanical data	
Contour for corrugated hose	without
Mechanical data   Material data	
Material housing	PUR
Locking material	PA
Mechanical data   Mounting data	
Looking techniques	Snap-in connector
Environmental characteristics   Climatic	
Operating temperature min.	-25 °C
Operating temperature max.	85 °C
Additional condition temperature range	depending on cable quality
Important installation notes	
Note on strain relief	Protect the connectors by suitable measures from mechanical loads, e.g. by the usage of cable ties.
Note on bending radius	<b>Attention:</b> Observe the permissible bending radii when laying cables, as the IP protection class can be endangered by excessive bending forces.
Installation   Cable	
wire arrangement	(orange-white, orange), (blue-white, blue), (brown-white, brown), (green-white, green)
Cable identification	S4W
Jacket Color	blue
Type of Certificate	cURus
Amount stranding	4

Stranding	2 wires twisted
Stranding (type 2)	4 Stranded joints twisted
Banding	Foil
wire arrangement	(orange-white, orange), (blue-white, blue), (brown-white, brown), (green-white, green)
Cable weight	74,8 g/m
Material jacket	TPE
Freedom from ingredients (jacket)	lead-free, CFC-free
Outer-diameter (jacket)	7,6 mm
Tolerance outer diameter (sheath)	± 5 %
Material wire insulation	HDPE
Amount wires	8
Outer diameter insulation	1,17 mm
Outer diameter tolerance core insulation	± 5 %
Ingredient freeness wire insulation	lead-free, CFC-free
Amount strands (wire)	7
Diameter of single wires	24 AWG
Conductor crosssection (wire)	24 AWG
Material conductor wire	copper stranded wire, tinned
Nominal voltage AC max.	300 V
Current load capacity (standard)	to DIN VDE 0298-4
Current load capacity min. wire	4 A
Electrical resistance line constant wire	59 Ω/km @ 20 °C
AC withstand voltage (wire - wire)	3 kV @ 60 s
Electrical capacity line constant (wire - wire)	49000 pF/km
Power frequency withstand voltage (wire - jacket)	3 kV @ 60 s
Min. operating temperature (static)	-40 °C
Max. operating temperature (fixed)	80 °C
Operating temperature min. (dynamic)	-5 °C
Operating temperature max. (dynamic)	70 °C
Flame resistance	UL 1581 § 1100 FT2   UL 1581 § 1090   IEC 60332-2-2
chemical resistance	Good, application-related testing
Gasoline resistance	Good, application-related testing
Oil resistance	DIN EN 60811-404   Good, application-related testing
Bending radius (fixed)	5 x Outer diameter
Bending radius (dynamic)	10 x Outer diameter
No. of bending cycles (C-track)	1 Mio. @ 25 °C
No. of torsion cycles	3 Mio. 25 °C
Torsion stress	± 270 °/m