

M12 female 0° A-cod. with cable V4A

PVC 8x0.25 gy 2m

Female straight

M12, 8-pole

Art-No. 7005 - M12 Lite - (plastic hexagonal screw) on request

⚠ NOTICE ⚠

Stainless steel 1.4404 (V4A)

Plastic housings with good resistance against chemicals and oils.

PRODUCT WILL BE DISCONTINUED BY MARCH 2023. PLEASE HAVE A LOOK AT THE ALTERNATIVE PRODUCTS.

The resistance to aggressive media should be individually tested for your application. Further details on request.

Further cable lengths on request.

Ürün Linki

örnekleme

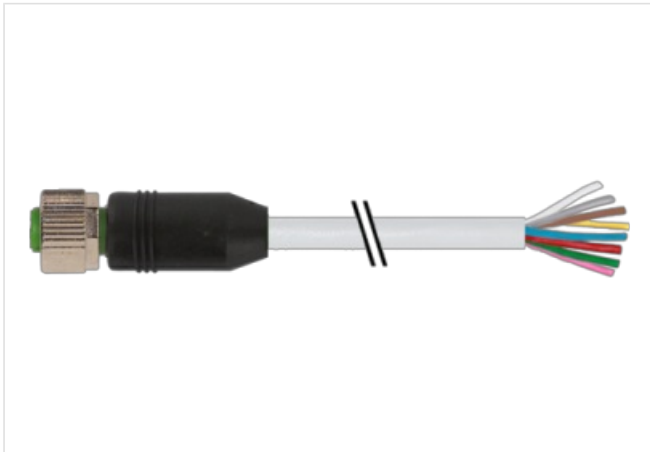

1	WH
2	BN
3	GN
4	YE
5	GY
6	PK
7	BU
8	RD

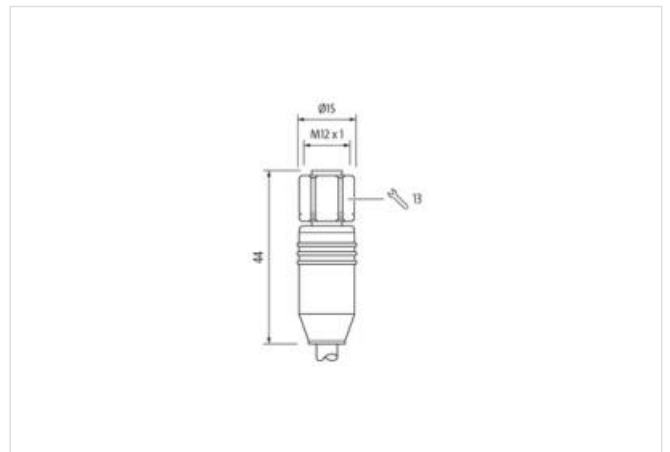
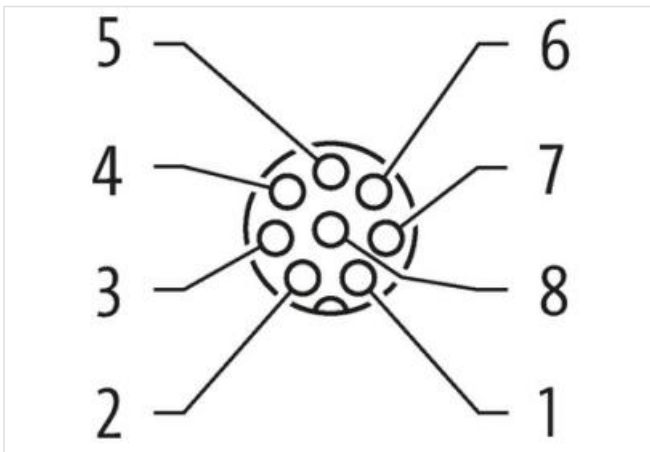

Ürün Image farklı olabilir



Cable length	2 m
Side 1	
Tightening torque	0,6 Nm
Mounting method	inserted, screwed
Family construction form	M12
Thread	M12 x 1
Coding	A
No. of poles	8
Width across flats	SW13
Degree of protection (EN IEC 60529)	IP65, IP66K, IP67

Side 2	
Stripping length (jacket)	60 mm

Ticari bilgiler	
ECLASS-6.0	27279218
ECLASS-6.1	27279218
ECLASS-7.0	27279218
ECLASS-8.0	27279218
ECLASS-9.0	27060311
ECLASS-10.1	27060311
ECLASS-11.1	27060311
ECLASS-12.0	27060311
ETIM-5.0	EC001855
GTIN	4048879850353
Gümrük tarife no (gtip)	85444290
Paket miktarı	1

Electrical data Supply	
Operating voltage AC max.	30 V
Operating voltage DC max.	30 V
Current operating per contact max.	2 A

Installation Connection	
Stripping length (jacket)	60 mm

Device protection Electrical	
Additional condition protection degree	inserted, screwed
Pollution Degree	3
Rated surge voltage	0,8 kV
Material group (IEC 60664-1)	I

Mechanical data Material data	
Locking material	Stainless steel 1.4404 (V4A)

Mechanical data Mounting data	
Mounting method	inserted, screwed, Shaking protection

Environmental characteristics Climatic	
Operating temperature min.	-25 °C
Operating temperature max.	85 °C
Additional condition temperature range	depending on cable quality

Installation Cable	
Cable identification	293
Jacket Color	gray
Amount stranding	1
Stranding	8 wires around Core filler twisted
Filler	yes

wire arrangement	brown, white, red, blue, pink, gray, yellow, green
Cable weight	58,3 g/m
Material jacket	PUR
Shore hardness jacket	78 ± 3 Shore A
Freedom from ingredients (jacket)	lead-free, cadmium-free, CFC-free, silicone-free
Outer-diameter (jacket)	6 mm
Tolerance outer diameter (sheath)	± 5 %
Material wire insulation	PVC
Amount wires	8
Outer diameter insulation	1,2 mm
Outer diameter tolerance core insulation	± 5 %
Shore hardness wire insulation	90 ± 3 Shore A
Ingredient freeness wire insulation	lead-free, cadmium-free, CFC-free, silicone-free
Amount strands (wire)	14
Diameter of single wires	0,15 mm
Conductor crosssection (wire)	0,25 mm ²
Material conductor wire	Stranded copper wire, bare
Conductor type (wire)	Strand class 5
Nominal voltage AC max.	300 V
Max. rated voltage (conductor - conductor)	300 V
Max. rated voltage (conductor - ground)	300 V
Current load capacity (standard)	to DIN VDE 0298-4
Current load capacity min. wire	2 A
Electrical resistance line constant wire	78 Ω/km @ 20 °C
AC withstand voltage (wire - wire)	2 kV @ 60 s
Power frequency withstand voltage (wire - jacket)	2 kV @ 60 s
Min. operating temperature (static)	-40 °C
Max. operating temperature (fixed)	70 °C
Operating temperature min. (dynamic)	-5 °C
Operating temperature max. (dynamic)	70 °C
UV resistance	DIN EN ISO 4892-2 A
Flame resistance	IEC 60332-2-2 UL 1581 § 1100 FT2 UL 1581 § 1090
chemical resistance	Good, application-related testing
Gasoline resistance	Good, application-related testing
Oil resistance	DIN EN 60811-404 Good, application-related testing
Bending radius (dynamic)	12 x Outer diameter