

MQ15-X-Power female 90°right, with cable

PUR 4x2,5 bk UL/CSA+drag chain 2m

Female 90°

MQ15, 4-pole

without cable sleeves

Plastic housings with good resistance against chemicals and oils.

The resistance to aggressive media should be individually tested for your application. Further details on request.

Further cable lengths on request.

제품 링크

일러스트

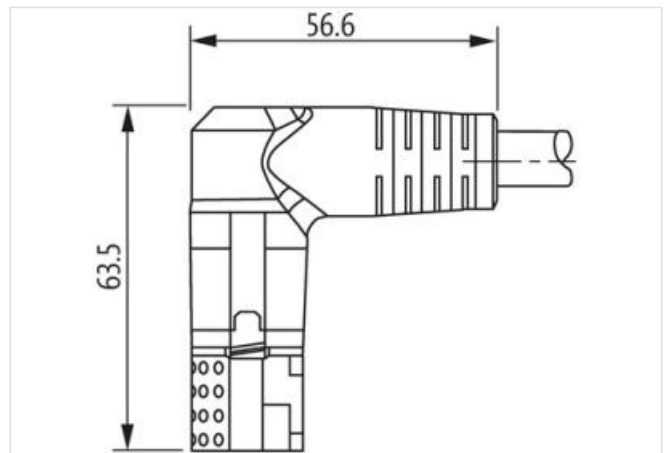
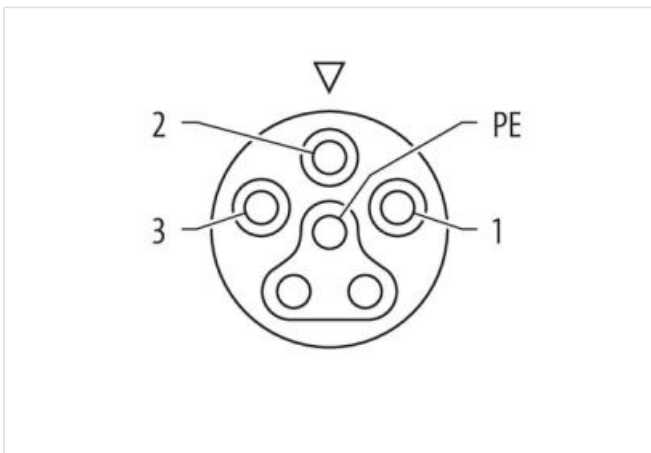

실제 제품은 이미지와 다를 수 있습니다.

Cable length	2 m
Side 1	
Mounting method	inserted, screwed
Coating contact	silver-plated
Family construction form	MQ15
Material contact	Copper alloy
No. of poles	4
Side 2	

Stripping length (jacket)	30 mm
---------------------------	-------

제품자료

ECLASS-6.0	27279218
ECLASS-6.1	27279218
ECLASS-7.0	27279218
ECLASS-8.0	27279218
ECLASS-9.0	27060327
ECLASS-10.1	27060311
ECLASS-11.1	27060311
ECLASS-12.0	27060327
ETIM-5.0	EC001855
GTIN	4048879624954
세번부호	85444290
포장단위	1

Electrical data | Supply

Operating voltage AC max.	600 V
Current operating per contact max.	16 A

Diagnostics

Status indication LED	no
-----------------------	----

Installation | Connection

Stripping length (jacket)	30 mm
Mating cycles min.	500

Installation | Pin assignment

Configuration	fully used
---------------	------------

Device protection | Electrical

Degree of protection (EN IEC 60529)	IP67
Additional condition protection degree	inserted, screwed
Pollution Degree	3
Rated surge voltage	4 kV
Material group (IEC 60664-1)	I

Mechanical data | Material data

Combustibility class housing (UL94)	HB
Material housing	Plastic
Material contact carrier	PA

Mechanical data | Mounting data

Looking techniques	bayonet-locking
--------------------	-----------------

Environmental characteristics | Climatic

Operating temperature min.	-25 °C
Operating temperature max.	80 °C
Additional condition temperature range	depending on cable quality

Important installation notes

Note on strain relief	Protect the connectors by suitable measures from mechanical loads, e.g. by the usage of cable ties.
Note on bending radius	Attention: Observe the permissible bending radii when laying cables, as the IP protection class can be endangered by excessive bending forces.

Installation | Cable

wire arrangement	black 1, black 2, black 3, green-yellow
Cable identification	P03
Jacket Color	black
wire arrangement	black 1, black 2, black 3, green-yellow
Material jacket	PUR

Freedom from ingredients (jacket)	halogen-free, LABS-free
Outer-diameter (jacket)	9 mm
Tolerance outer diameter (sheath)	± 5 %
Material wire insulation	TPE
Amount wires	4
Ingredient freeness wire insulation	halogen-free, LABS-free
Conductor crosssection (wire)	2,5 mm ²
Material conductor wire	Stranded copper wire, bare
Nominal voltage AC max.	1000 V
Electrical resistance line constant wire	8 Ω/km @ 20 °C
AC withstand voltage (wire - wire)	4 kV
Power frequency withstand voltage (wire - jacket)	4 kV
Min. operating temperature (static)	-50 °C
Max. operating temperature (fixed)	80 °C
Operating temperature min. (dynamic)	-20 °C
Operating temperature max. (dynamic)	70 °C
Flame resistance	IEC 60332-2-2 UL 1581 § 1090 UL 1581 § 1100 FT2
chemical resistance	Good, application-related testing
Gasoline resistance	Good, application-related testing
Oil resistance	DIN EN 60811-404 Good, application-related testing
Bending radius (fixed)	4 x Outer diameter
Bending radius (dynamic)	10 x Outer diameter
No. of bending cycles (C-track)	5 Mio.
Travel speed (C-track)	3 m/s
Torsion stress	± 15 °/m