

**MQ15 male 0° / MQ15 female 0° type 2**

PUR 6x2.5 bk UL/CSA+drag ch. 7m

MQ15, 6-pole

Male straight – female straight  
with cable sleeves

Plastic housings with good resistance against chemicals and oils.

The resistance to aggressive media should be individually tested for your application. Further details on request.

Further cable lengths on request.

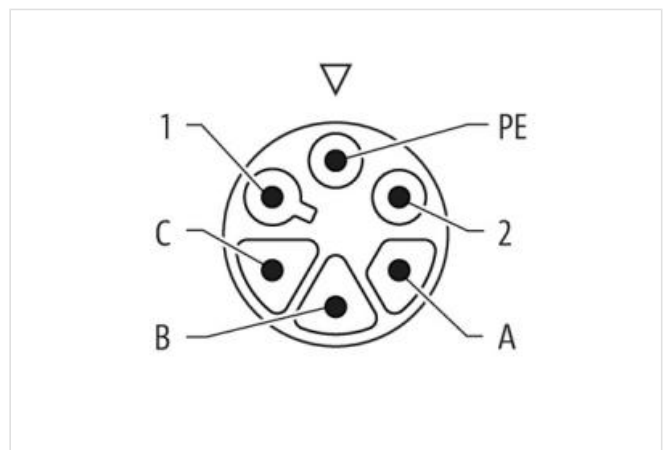
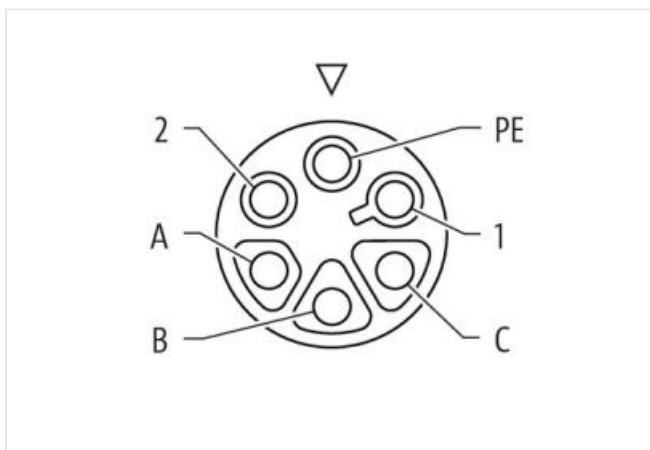
[Link do produto](#)**Ilustração**

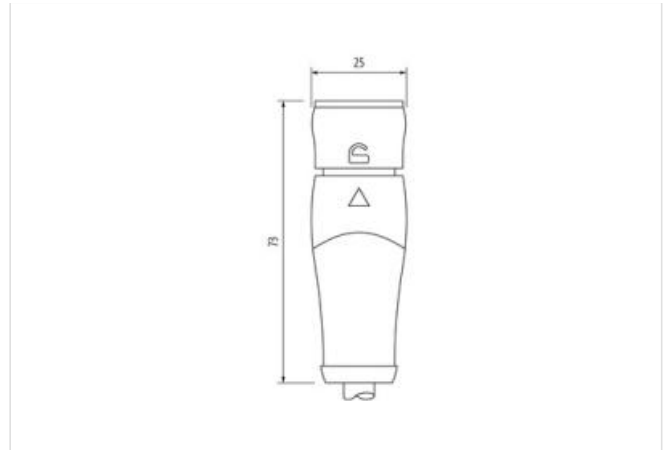
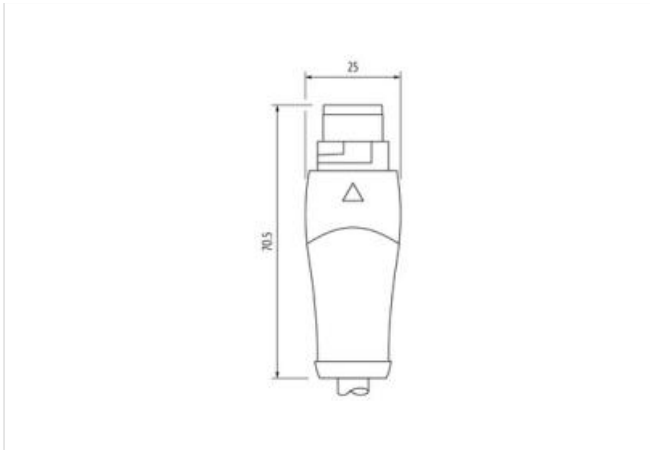

Produto pode diferir da imagem



Cable length 7 m

#### Side 1

|   |                  |
|---|------------------|
| Mounting method                           | inserted, locked |
| Coating contact                           | silver-plated    |
| Family construction form                  | MQ15             |
| suitable for corrugated tube (internal Ø) | 18 mm            |
| Gender                                    | male             |
| Cable outlet                              | straight         |
| Coding                                    | Type 2           |
| Material contact                          | Copper alloy     |
| No. of poles                              | 6                |
| Degree of protection (EN IEC 60529)       | IP65, IP67       |

#### Side 2

|   |                  |
|---|------------------|
| Mounting method                           | inserted, locked |
| Coating contact                           | silver-plated    |
| Family construction form                  | MQ15             |
| Gender                                    | female           |
| suitable for corrugated tube (internal Ø) | 18 mm            |
| Cable outlet                              | straight         |
| Coding                                    | Type 2           |
| Material contact                          | Copper alloy     |
| No. of poles                              | 6                |
| Degree of protection (EN IEC 60529)       | IP65, IP67       |

#### Dados comerciais

|             |          |
|-------------|----------|
| ECLASS-6.0  | 27279218 |
| ECLASS-6.1  | 27279218 |
| ECLASS-7.0  | 27279218 |
| ECLASS-8.0  | 27279218 |
| ECLASS-9.0  | 27060327 |
| ECLASS-10.1 | 27060311 |
| ECLASS-11.1 | 27060311 |
| ECLASS-12.0 | 27060327 |

|   |   |
|---|---|
| ETIM-5.0  | EC001855  |
| Classificação fiscal                            | 85444290  |
| GTIN  | 4065909067505   |
| Quantidade por embalagem                        | 1   |
| <b>Electrical data   Supply</b>                 |   |
| Operating voltage DC                            | 48 V  |
| Operating current per power contact max.        | 20 A  |
| Operating current per signal contact max.       | 4 A   |
| <b>Diagnostics</b>                              |   |
| Status indication LED                           | no  |
| <b>Installation   Pin assignment</b>            |   |
| Coding  | Type 2  |
| Configuration                                   | fully used  |
| <b>Device protection   Electrical</b>           |   |
| Additional condition protection degree          | inserted, locked  |
| Pollution Degree                                | 3   |
| Rated surge voltage                             | 0,8 kV  |
| Material group (IEC 60664-1)                    | I   |
| <b>Mechanical data   Material data</b>          |   |
| Material housing                                | PUR   |
| Material contact carrier                        | PA  |
| Locking material                                | POM   |
| <b>Mechanical data   Mounting data</b>          |   |
| Looking techniques                              | bayonet-locking   |
| <b>Environmental characteristics   Climatic</b> |   |
| Operating temperature min.                      | -30 °C  |
| Operating temperature max.                      | 85 °C   |
| Additional condition temperature range          | depending on cable quality  |
| <b>Important installation notes</b>             |   |
| Note on strain relief                           | Protect the connectors by suitable measures from mechanical loads, e.g. by the usage of cable ties.   |
| Note on bending radius                          | <b>Attention:</b> Observe the permissible bending radii when laying cables, as the IP protection class can be endangered by excessive bending forces. |
| <b>Conformity</b>                               |   |
| Product standard                                | IEC 61076-2-116   |
| <b>Installation   Cable</b>                     |   |
| wire arrangement                                | black 5, black 4, black 3, black 2, black 1, green-yellow   |
| Cable identification                            | P63   |
| Cable Type                                      | 3   |
| Jacket Color                                    | black   |
| Type of Certificate                             | cURus   |
| Stranding                                       | 6 wires around Filler twisted   |
| Filler  | yes   |
| wire arrangement                                | black 5, black 4, black 3, black 2, black 1, green-yellow   |
| Cable weight                                    | 227,7 g/m   |
| Material jacket                                 | PUR   |
| Shore hardness jacket                           | 90 ± 5 Shore A  |
| Freedom from ingredients (jacket)               | lead-free, cadmium-free, CFC-free, halogen-free, silicone-free  |
| Outer-diameter (jacket)                         | 10,5 mm   |
| Tolerance outer diameter (sheath)               | ± 5 %   |
| Material wire insulation                        | PP  |
| Amount wires                                    | 6   |

|   |  |
|---|--|
| Outer diameter insulation                         | 2,85 mm  |
| Outer diameter tolerance core insulation          | ± 5 %  |
| Ingredient freeness wire insulation               | lead-free, cadmium-free, CFC-free, halogen-free, silicone-free |
| Amount strands (wire)                             | 140  |
| Diameter of single wires                          | 0,15 mm  |
| Conductor crosssection (wire)                     | 2,5 mm <sup>2</sup>  |
| Material conductor wire                           | Stranded copper wire, bare                                     |
| Conductor type (wire)                             | strand class 6   |
| Shore hardness wire insulation (Data)             | 60 ± 5 Shore D   |
| Nominal voltage AC max.                           | 1000 V   |
| Current load capacity (standard)                  | to DIN VDE 0298-4  |
| Current load capacity min. wire                   | 19,5 A   |
| Electrical resistance line constant wire          | 8 Ω/km @ 20 °C   |
| AC withstand voltage (wire - wire)                | 10 kV  |
| Power frequency withstand voltage (wire - jacket) | 10 kV  |
| Min. operating temperature (static)               | -50 °C   |
| Max. operating temperature (fixed)                | 80 °C / 90 °C @ 10000 h Operation                              |
| Operating temperature min. (dynamic)              | -25 °C   |
| Operating temperature max. (dynamic)              | 80 °C / 90 °C @ 10000 h Operation                              |
| UV resistance                                     | DIN EN ISO 4892-2 A  |
| Flame resistance                                  | UL 1581 § 1090   IEC 60332-2-2   UL 1581 § 1100 FT2            |
| chemical resistance                               | Good, application-related testing                              |
| Gasoline resistance                               | Good, application-related testing                              |
| Oil resistance                                    | DIN EN 60811-404   Good, application-related testing           |
| Bending radius (fixed)                            | 5 x Outer diameter   |
| Bending radius (dynamic)                          | 10 x Outer diameter  |
| No. of bending cycles (C-track)                   | 5 Mio. @ 25 °C   |
| Traversing distance (C-track)                     | 5 m @ 25 °C  |
| Travel speed (C-track)                            | 3,3 m/s @ 25 °C  |
| No. of torsion cycles                             | 2 Mio. 25 °C   |
| Torsion stress                                    | ± 180 °/m @ 25 °C  |
| Torsion speed                                     | 35 cycles/min 25 °C  |