

### RJ45 Push Pull male 0° with cable

PUR 1x4xAWG22 shielded gn UL/CSA 7,5m

Male straight  
RJ45PP, 4-pole  
shielded

Plastic housings with good resistance against chemicals and oils.  
The resistance to aggressive media should be individually tested for your application. Further details on request.  
Further cable lengths on request.

### Ürün Linki

örnekleme

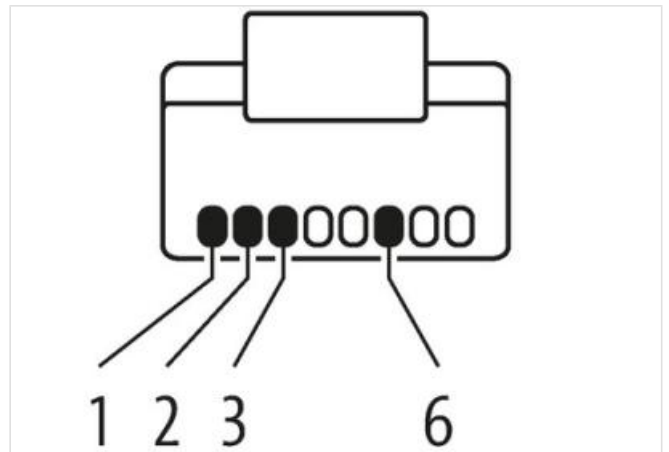
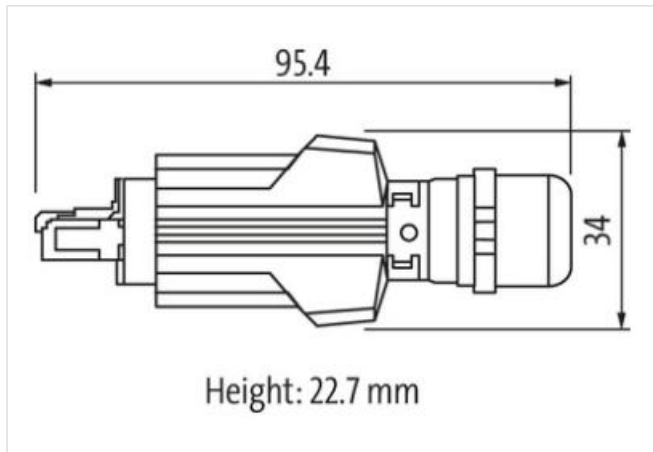
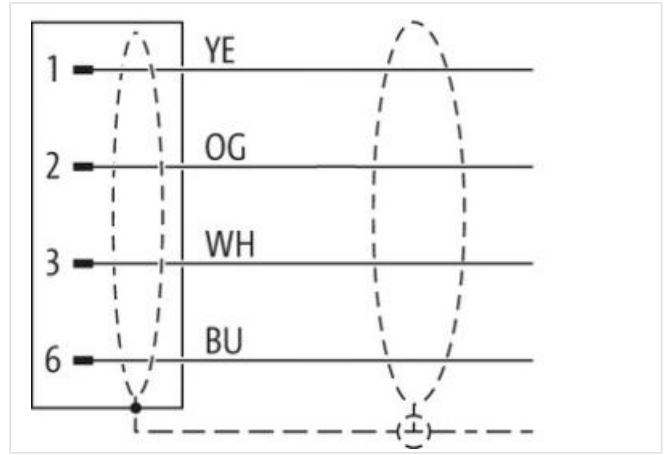
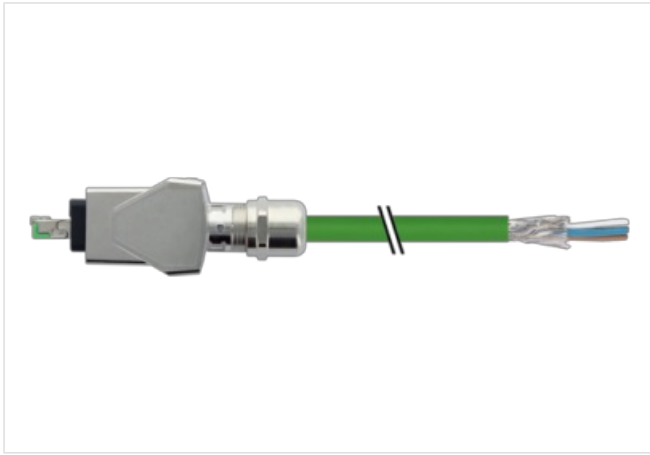

Ürün Image farklı olabilir



Cable length

7,5 m

Side 1

Family construction form	RJ45
Degree of protection (EN IEC 60529)	IP65, IP67
<b>Ticari bilgiler</b>	
ECLASS-6.0	27061801
ECLASS-6.1	27060307
ECLASS-7.0	27060307
ECLASS-8.0	27060307
ECLASS-9.0	27060307
ECLASS-10.1	27060307
ECLASS-11.1	27060307
ECLASS-12.0	27060307
ETIM-5.0	EC002599
GTIN	4065909000403
Gümrük tarife no (gtip)	85444210
Paket miktarı	1
<b>Electrical data   Supply</b>	
Operating voltage DC max.	60 V
Current operating per contact max.	1,5 A
<b>Industrial communication</b>	
Transfer parameters	CAT5, Class D (ISO/IEC 11801)
Data transmission rate max.	100 MBit/s
<b>Device protection   Electrical</b>	
Pollution Degree	3
Rated surge voltage	1 kV
Material group (IEC 60664-1)	I
<b>Mechanical data</b>	
Contour for corrugated hose	without
<b>Mechanical data   Material data</b>	
Coating locking	Nickeled
Locking material	Zinc die-casting
<b>Mechanical data   Mounting data</b>	
Looking techniques	Push Pull
<b>Environmental characteristics   Climatic</b>	
Operating temperature min.	-40 °C
Operating temperature max.	70 °C
Additional condition temperature range	depending on cable quality
<b>Important installation notes</b>	
Note on strain relief	Protect the connectors by suitable measures from mechanical loads, e.g. by the usage of cable ties.
Note on bending radius	<b>Attention:</b> Observe the permissible bending radii when laying cables, as the IP protection class can be endangered by excessive bending forces.
<b>Installation   Cable</b>	
wire arrangement	white, yellow, blue, orange
Cable identification	794
Jacket Color	green
Type of Certificate	cURus
Amount stranding	1
Stranding	4 wires around Filler twisted
Cable shielding (type)	copper braid, tinned
Cable shielding (coverage)	85 %
Banding	Fleece, Foil

Filler	yes
wire arrangement	white, yellow, blue, orange
Cable weight	75,87 g/m
Material jacket	PUR
Shore hardness jacket	89 Shore A
Freedom from ingredients (jacket)	lead-free, cadmium-free, CFC-free, halogen-free, silicone-free
Outer-diameter (jacket)	6,7 mm
Tolerance outer diameter (sheath)	± 5 %
Material inner jacket	FRNC
Color (inner jacket)	white
Material wire insulation	PE
Amount wires	4
Outer diameter insulation	1,55 mm
Outer diameter tolerance core insulation	± 5 %
Shore hardness wire insulation	65 Shore D
Ingredient freeness wire insulation	lead-free, CFC-free, halogen-free
Amount strands (wire)	7
Diameter of single wires	22 AWG
Conductor crosssection (wire)	22 AWG
Material conductor wire	Stranded copper wire, bare
Nominal voltage AC max.	300 V
Current load capacity (standard)	to DIN VDE 0298-4
Current load capacity min. wire	4,8 A
Characteristic impedance	100 Ω ± 15 %
Electrical resistance line constant wire	55 Ω/km @ 20 °C
AC withstand voltage (wire - wire)	2 kV @ 60 s
Electrical capacity line constant (wire - wire)	52000 pF/km
Power frequency withstand voltage (wire - jacket)	2 kV @ 60 s
AC withstand voltage (wire - shield)	2 kV @ 60 s
Min. operating temperature (static)	-40 °C
Max. operating temperature (fixed)	80 °C
Operating temperature min. (dynamic)	-30 °C
Operating temperature max. (dynamic)	70 °C
Flame resistance	UL 1581 § 1090   IEC 60332-2-2   UL 1581 § 1100 FT2
chemical resistance	Good, application-related testing
Gasoline resistance	Good, application-related testing
Oil resistance	Good, application-related testing   DIN EN 60811-404
Bending radius (fixed)	6 x Outer diameter
Bending radius (dynamic)	12 x Outer diameter