

7/8" male 90° / 7/8" female 90°

PUR 5x1.5 gy UL/CSA+drag ch. 25m

Male 90° – female 90°

7/8" – 7/8", 5-pole

Power cable

Further cable lengths on request.

Plastic housings with good resistance against chemicals and oils.

The resistance to aggressive media should be individually tested for your application. Further details on request.

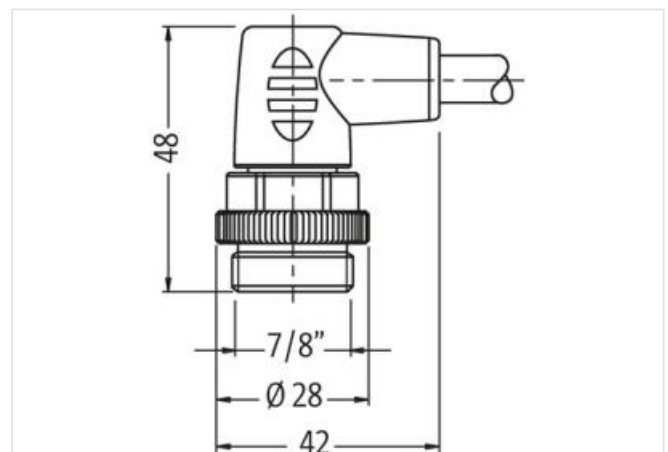
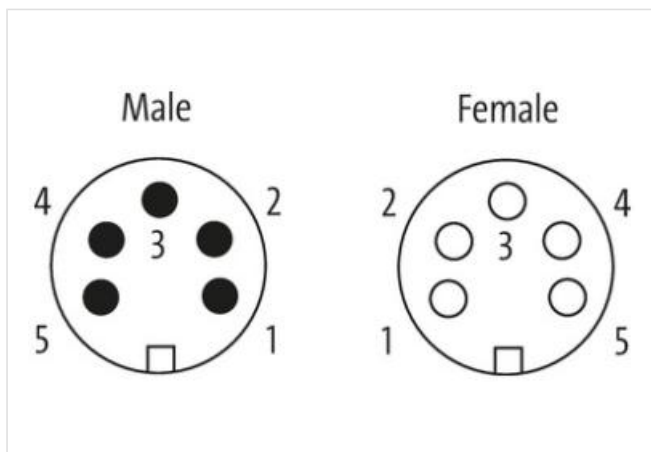
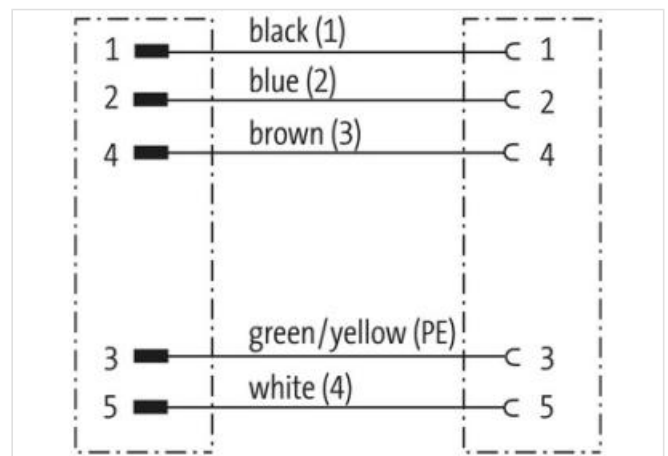
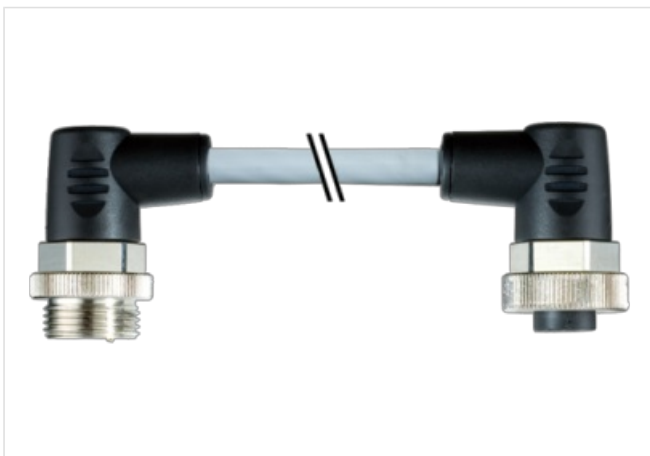
[Link to Product](#)**Illustration**

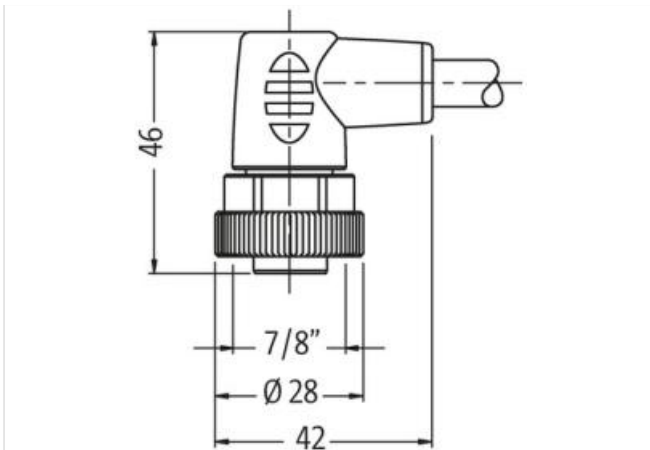

Product may differ from Image



Cable length 25 m

Side 1

Tightening torque 1,5 Nm

Family construction form 7/8"

Thread 7/8"

Side 2

Tightening torque 1,5 Nm

Thread 7/8"

Commercial data

ECLASS-6.0 27279218

ECLASS-6.1 27279218

ECLASS-7.0 27279218

ECLASS-8.0 27279218

ECLASS-9.0 27060327

ECLASS-10.1 27060311

ECLASS-11.1 27060311

ECLASS-12.0 27060327

ETIM-5.0 EC001855

customs tariff number 85444290

GTIN 4048879619394

Packaging unit 1

Electrical data | Supply

Current operating per contact max. 12 A

Current phase - neutral 230 V

Current phase - phase 400 V

Device protection | Electrical

Degree of protection (EN IEC 60529) IP67

Additional condition protection degree inserted, screwed

Rated surge voltage 3 kV

Mechanical data | Mounting data

Mounting method inserted, screwed, Shaking protection

Environmental characteristics Climatic	
Operating temperature min.	-25 °C
Operating temperature max.	85 °C
Additional condition temperature range	depending on cable quality
Important installation notes	
Note on strain relief	Protect the connectors by suitable measures from mechanical loads, e.g. by the usage of cable ties.
Note on bending radius	Attention: Observe the permissible bending radii when laying cables, as the IP protection class can be endangered by excessive bending forces.
Installation Cable	
wire arrangement	green-yellow, blue 2, black 1, white 4, brown 3
Cable identification	961
Cable Type	3
Printing color of wire insulation	black (white isolation), white (isolation blue), white (isolation brown), white (isolation black)
Jacket Color	gray
Type of Certificate	cURus
Amount stranding	1
Stranding	5 wires around Filler twisted
Filler	yes
wire arrangement	green-yellow, blue 2, black 1, white 4, brown 3
Cable weight	129,8 g/m
Material jacket	PUR
Shore hardness jacket	90 ± 5 Shore A
Freedom from ingredients (jacket)	lead-free, cadmium-free, CFC-free, halogen-free, silicone-free
Outer-diameter (jacket)	8 mm
Tolerance outer diameter (sheath)	± 5 %
Material wire insulation	PP
Amount wires	5
Outer diameter insulation	2,3 mm
Outer diameter tolerance core insulation	± 5 %
Shore hardness wire insulation	60 ± 5 Shore D
Ingredient freeness wire insulation	lead-free, cadmium-free, CFC-free, halogen-free, silicone-free
Printing color of wire insulation	black (white isolation), white (isolation blue), white (isolation brown), white (isolation black)
Amount strands (wire)	84
Diameter of single wires	0,15 mm
Conductor crosssection (wire)	1,5 mm ²
Material conductor wire	Stranded copper wire, bare
Conductor type (wire)	strand class 6
Nominal voltage AC max.	1000 V
Current load capacity (standard)	to DIN VDE 0298-4
Current load capacity min. wire	13,5 A
Electrical resistance line constant wire	13,3 Ω/km @ 20 °C
AC withstand voltage (wire - wire)	10 kV @ 60 s
Power frequency withstand voltage (wire - jacket)	10 kV @ 60 s
Min. operating temperature (static)	-50 °C
Max. operating temperature (fixed)	80 °C / 90 °C @ 10000 h Operation
Operating temperature min. (dynamic)	-25 °C
Operating temperature max. (dynamic)	80 °C / 90 °C @ 10000 h Operation
Flame resistance	UL 1581 § 1100 FT2 IEC 60332-2-2 UL 1581 § 1090
chemical resistance	Good, application-related testing
Gasoline resistance	Good, application-related testing
Oil resistance	DIN EN 60811-404 Good, application-related testing
Bending radius (fixed)	5 x Outer diameter

Bending radius (dynamic)	10 x Outer diameter
No. of bending cycles (C-track)	5 Mio. @ 25 °C
Traversing distance (C-track)	5 m @ 25 °C
Travel speed (C-track)	3,3 m/s @ 25 °C
No. of torsion cycles	5 Mio.
Torsion stress	± 180 °/m
Torsion speed	35 cycles/min