

M12 male 0° / M12 female 0° A-cod. shielded

PUR 4x0.5+2x0.25 shielded gn UL/CSA+drag ch. 24m

Cube67

Male straight – female straight

M12 – M12, 6-pole

shielded

A-coded

Hybrid cable

Plastic housings with good resistance against chemicals and oils.

The resistance to aggressive media should be individually tested for your application. Further details on request.

Further cable lengths on request.

제품 링크

일러스트

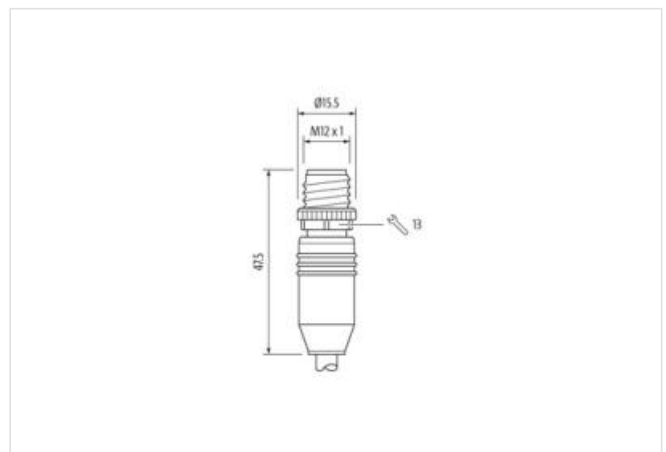
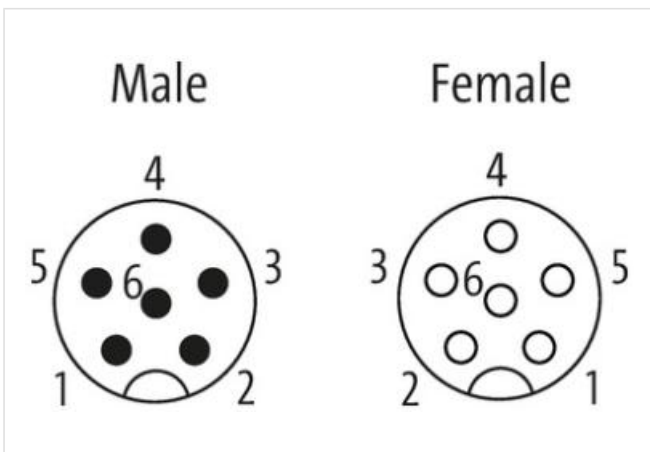



실제 제품은 이미지와 다를 수 있습니다.



Cable length 24 m

Side 1

Tightening torque	0,6 Nm
Mounting method	inserted, screwed
Coating contact	gold plated
Family construction form	M12
Thread	M12 x 1
Coding	A
Material contact	Copper alloy
Material	PUR
No. of poles	6
Width across flats	SW13

Side 2

Tightening torque	0,6 Nm
Mounting method	inserted, screwed
Coating contact	gold plated
Family construction form	M12
Thread	M12 x 1
Coding	A
Material contact	Copper alloy
Material	PUR
No. of poles	6

제품자료

ECLASS-6.0	27061801
ECLASS-6.1	27060307
ECLASS-7.0	27060307
ECLASS-8.0	27060307
ECLASS-9.0	27060307
ECLASS-10.1	27060307
ECLASS-11.1	27060307
ECLASS-12.0	27060307
ETIM-5.0	EC001855

GTIN	4065909040461
세번부호	85444290
포장단위	1

Electrical data | Supply

Operating voltage AC max.	30 V
Operating voltage DC max.	30 V
Operating voltage AC (UL-listed)	30 V
Operating voltage DC (UL-listed)	30 V
Current operating per contact max.	4 A

Diagnostics

Status indication LED	no
-----------------------	----

Device protection | Electrical

Degree of protection (EN IEC 60529)	IP65, IP67
Additional condition protection degree	inserted, screwed
Pollution Degree	3
Rated surge voltage	0,8 kV
Material group (IEC 60664-1)	I

Mechanical data | Material data

Coating locking	Nickel
Material gasket	FKM
Locking material	Zinc die-casting

Mechanical data | Mounting data

Mounting method	inserted, screwed, Shaking protection
-----------------	---------------------------------------

Environmental characteristics | Climatic

Operating temperature min.	-25 °C
Operating temperature max.	85 °C
Additional condition temperature range	depending on cable quality

Important installation notes

Note on strain relief	Protect the connectors by suitable measures from mechanical loads, e.g. by the usage of cable ties.
Note on bending radius	Attention: Observe the permissible bending radii when laying cables, as the IP protection class can be endangered by excessive bending forces.

Installation | Cable

wire arrangement	(gray, pink), blue, white, brown, black
Cable identification	802
Function cable	Hybrid, Signal, Data
Jacket Color	green
Type of Certificate	cURus
Amount stranding	1
Stranding	2 wires twisted
Amount stranding (type 2)	1
Stranding (type 2)	4 wires with Stranding combination with 3 Filler twisted
Cable shielding (type)	copper braid, tinned
Cable shielding (coverage)	80 %
Banding	Fleece
Filler	yes
wire arrangement	(gray, pink), blue, white, brown, black
Cable weight	77 g/m
Material jacket	PUR
Freedom from ingredients (jacket)	lead-free, CFC-free, halogen-free
Outer-diameter (jacket)	6,6 mm
Tolerance outer diameter (sheath)	± 5 %

Material wire insulation	PP
Amount wires	4
Outer diameter insulation	1,4 mm
Outer diameter tolerance core insulation	± 5 %
Ingredient freeness wire insulation	lead-free, cadmium-free, CFC-free, halogen-free, silicone-free
Amount strands (wire)	64
Diameter of single wires	0,1 mm
Conductor crosssection (wire)	0,5 mm ²
Material conductor wire	Stranded copper wire, bare
Conductor type (wire)	strand class 6
Material wire insulation (Data)	PP
Outer diameter wire insulation (Data)	1,1 mm
Tolerance outer diameter wire insulation (data)	± 5 %
Ingredient freeness wire insulation (Data)	lead-free, cadmium-free, CFC-free, halogen-free, silicone-free
Amount wires (Data)	2
Amount strands wire (Data)	32
Diameter of single wires (Data)	0,1 mm
Conductor crosssection wire (Data)	0,25 mm ²
Material conductor wire (Data)	Stranded copper wire, bare
Wire conductor type (Data)	strand class 6
Nominal voltage AC max.	300 V
Current load capacity (standard)	to DIN VDE 0298-4
Current load capacity min. wire	6,3 A
Current load capacity min. Wire (Data)	3,2 A
Electrical resistance line constant wire	39 Ω/km @ 20 °C
Electrical resistance coating wire (Data)	79 Ω/km @ 20 °C
AC withstand voltage (wire - wire)	1,5 kV @ 60 s
Electric inductivity line constant	0,65 mH/km
Electrical capacity line constant (wire - wire)	63000 pF/km
Power frequency withstand voltage (wire - jacket)	1,5 kV @ 60 s
AC withstand voltage (wire - shield)	1,2 kV @ 60 s
Isolation resistance	2000 MΩ × km
Min. operating temperature (static)	-50 °C
Max. operating temperature (fixed)	90 °C
Operating temperature min. (dynamic)	-30 °C
Operating temperature max. (dynamic)	70 °C
Flame resistance	IEC 60332-2-2 UL 1581 § 1100 FT2 UL 1581 § 1090
chemical resistance	Good, application-related testing
Gasoline resistance	Good, application-related testing
Oil resistance	DIN EN 60811-404 Good, application-related testing
Bending radius (fixed)	5 x Outer diameter
Bending radius (dynamic)	10 x Outer diameter
No. of bending cycles (C-track)	5 Mio. @ 25 °C
Traversing distance (C-track)	10 m @ 25 °C
Travel speed (C-track)	2 m/s @ 25 °C
Torsion stress	± 180 °/m