

**M12 male 0° D-cod. / RJ45 male 0° shielded**

PUR 1x4xAWG22 shielded gn UL/CSA+torsion 50m

Male straight – male straight

M12 – RJ45, 4-pole

D-coded

shielded

Ethernet CAT5

Further cable lengths on request.

Plastic housings with good resistance against chemicals and oils.

The resistance to aggressive media should be individually tested for your application. Further details on request.

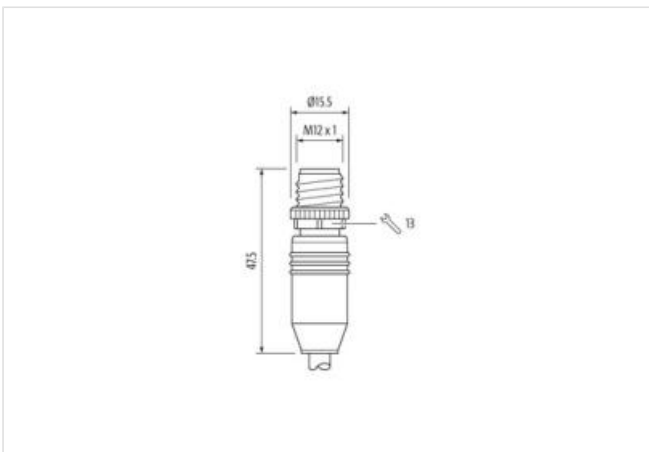
**[Link to Product](#)****Illustration**

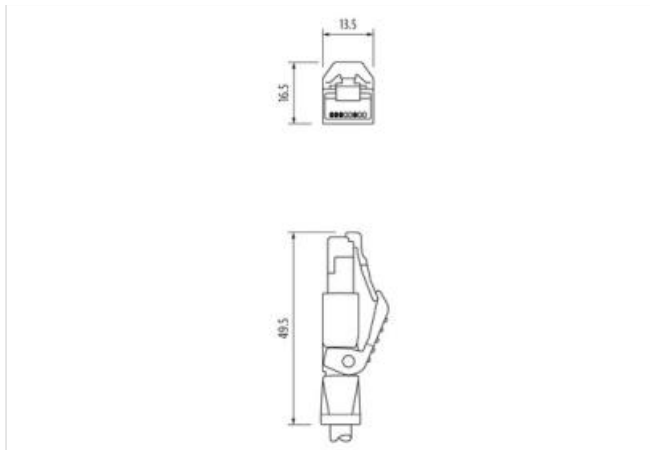

Product may differ from Image



Cable length 50 m

**Side 1**

Tightening torque	0,6 Nm
Mounting method	inserted, screwed
Family construction form	M12
Thread	M12 x 1
Cable outlet	straight
Coding	D
Material	PUR
No. of poles	4
Width across flats	SW13
Degree of protection (EN IEC 60529)	IP67

**Side 2**

Mounting method	pluggable
Family construction form	RJ45
Cable outlet	straight
Material	PUR
No. of poles	4
Degree of protection (EN IEC 60529)	IP20

**取引条件**

ECLASS-6.0	27061801
ECLASS-6.1	27060307
ECLASS-7.0	27060307
ECLASS-8.0	27060307
ECLASS-9.0	27060307
ECLASS-10.1	27060307
ECLASS-11.1	27060307
ECLASS-12.0	27060307
ETIM-5.0	EC002599
GTIN	4048879876483
HSコード	85444290
Packaging unit	1

**Electrical data | Supply**

このデータシートに含まれる情報は最大限の注意を払って作成されました。

Liability for the correctness completeness and topicality of the information is restricted to gross negligence. Version: 2024-06-26

Operating voltage DC max.	60 V
Current operating per contact max.	1,5 A
<b>Industrial communication</b>	
Transfer parameters	CAT5, Class D (ISO/IEC 11801:2002), (EN 50173-1)
Data transmission rate max.	100 MBit/s
<b>Industrial communication   Ethernet functionality</b>	
duplex	Full duplex
<b>Device protection   Electrical</b>	
Additional condition protection degree	inserted, screwed
Pollution Degree	3
Rated surge voltage	1 kV
Material group (IEC 60664-1)	I
<b>Mechanical data</b>	
Contour for corrugated hose	without
<b>Mechanical data   Material data</b>	
Coating locking	Nickeled
Locking material	Zinc die-casting
<b>Mechanical data   Mounting data</b>	
Mounting method	inserted, screwed, Shaking protection
<b>Environmental characteristics   Climatic</b>	
Operating temperature min.	-25 °C
Operating temperature max.	85 °C
Additional condition temperature range	depending on cable quality
<b>Important installation notes</b>	
Note on strain relief	Protect the connectors by suitable measures from mechanical loads, e.g. by the usage of cable ties.
Note on bending radius	<b>Attention:</b> Observe the permissible bending radii when laying cables, as the IP protection class can be endangered by excessive bending forces.
<b>Conformity</b>	
Product standard	DIN EN 61076-2-101 (M12)
<b>Installation   Cable</b>	
wire arrangement	white, yellow, blue, orange
Cable identification	793
Jacket Color	green
Type of Certificate	cURus
Amount stranding	1
Stranding	4 wires around Filler twisted
Cable shielding (type)	copper braid, tinned
Cable shielding (coverage)	85 %
Banding	Fleece, Foil
Filler	yes
wire arrangement	white, yellow, blue, orange
Cable weight	69,3 g/m
Material jacket	PUR
Shore hardness jacket	90 Shore A
Freedom from ingredients (jacket)	lead-free, cadmium-free, CFC-free, halogen-free, silicone-free
Outer-diameter (jacket)	6,6 mm
Tolerance outer diameter (sheath)	± 5 %
Material wire insulation	PE
Amount wires	4
Outer diameter insulation	1,55 mm

Outer diameter tolerance core insulation	± 5 %
Shore hardness wire insulation	65 Shore D
Ingredient freeness wire insulation	lead-free, CFC-free, halogen-free
Amount strands (wire)	19
Diameter of single wires	22 AWG
Conductor crosssection (wire)	22 AWG
Material conductor wire	copper stranded wire, tinned
Nominal voltage AC max.	300 V
Current load capacity (standard)	to DIN VDE 0298-4
Current load capacity min. wire	4,8 A
Characteristic impedance	100 Ω ± 15 % MHz
Electrical resistance line constant wire	59,4 Ω/km @ 20 °C
AC withstand voltage (wire - wire)	2 kV @ 60 s
Electrical capacity line constant (wire - wire)	52000 pF/km
Power frequency withstand voltage (wire - jacket)	2 kV @ 60 s
AC withstand voltage (wire - shield)	2 kV @ 60 s
Min. operating temperature (static)	-40 °C
Max. operating temperature (fixed)	80 °C
Operating temperature min. (dynamic)	-20 °C
Operating temperature max. (dynamic)	60 °C
Flame resistance	IEC 60332-2-2   UL 1581 § 1090   UL 1581 § 1100 FT2
chemical resistance	Good, application-related testing
Gasoline resistance	Good, application-related testing
Oil resistance	Good, application-related testing   DIN EN 60811-404
Bending radius (fixed)	8 x Outer diameter
Bending radius (dynamic)	12 x Outer diameter
No. of torsion cycles	4 Mio.
Torsion stress	± 180 °/m