

**M12 male 90° / M12 female 90° A-cod. LED**

PUR 4x0.34 gy UL/CSA+drag ch. 2m

Male 90° – female 90°

M12 – M12, 4-pole

3× LED (PNP), (NPN) on request

Art-No. 7005 - M12 Lite - (plastic hexagonal screw) on request

Plastic housings with good resistance against chemicals and oils.

The resistance to aggressive media should be individually tested for your application. Further details on request.

Further cable lengths on request.

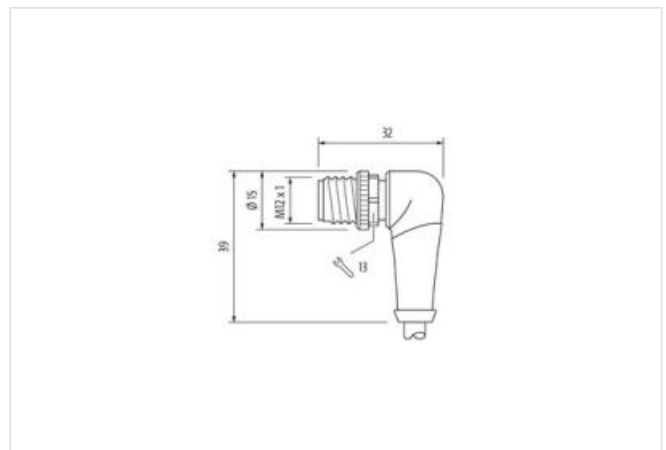
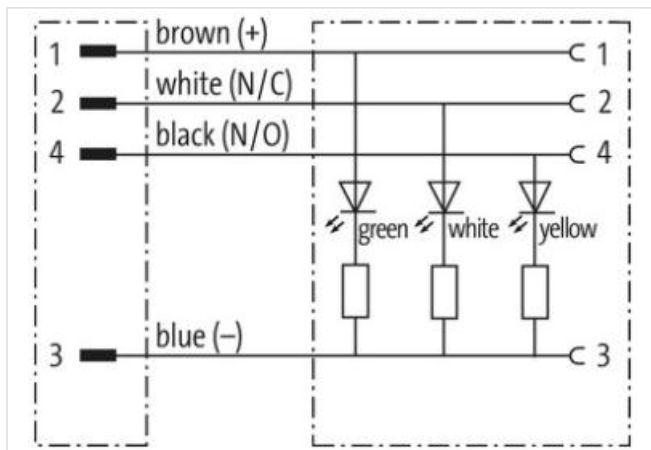
**[Link to Product](#)****Illustration**



Product may differ from Image



Cable length 2 m

**Side 1**

Tightening torque 0,6 Nm

Mounting method inserted, screwed

Family construction form M12

Thread M12 x 1

suitable for corrugated tube (internal Ø) 10 mm

Coding A

Material PUR

Width across flats SW13

Degree of protection (EN IEC 60529) IP66K, IP67

**Side 2**

Tightening torque 0,6 Nm

Mounting method inserted, screwed

Family construction form M12

Thread M12 x 1

suitable for corrugated tube (internal Ø) 10 mm

Coding A

Material PUR

Width across flats SW13

Degree of protection (EN IEC 60529) IP66K, IP67

**取引条件**

ECLASS-6.0 27279218

ECLASS-7.0 27279218

ECLASS-8.0 27279218

ECLASS-9.0 27060311

ECLASS-10.1 27060311

ECLASS-11.1 27060311

ECLASS-12.0 27060311

ETIM-5.0 EC001855

GTIN 4048879166775

HSコード 85444290

Packaging unit 1

このデータシートに含まれる情報は最大限の注意を払って作成されました。

Liability for the correctness completeness and topicality of the information is restricted to gross negligence. Version: 2024-06-26

Electrical data   Supply	
Operating voltage DC	24 V
Operating voltage DC min.	18 V
Operating voltage DC max.	30 V
Operating voltage DC max. (UL-listed)	30 V
Current operating per contact max.	4 A
Installation   Connection	
Mounting set	M12 x 1
Device protection   Electrical	
Additional condition protection degree	inserted, screwed
Pollution Degree	3
Material group (IEC 60664-1)	I
Mechanical data   Material data	
Coating locking	Nickeled
Coating of fitting	nickel plated
Locking material	Zinc die-casting
Material screw connection	Zinc die-casting
Mechanical data   Mounting data	
Mounting method	inserted, screwed, Shaking protection
Environmental characteristics   Climatic	
Operating temperature min.	-25 °C
Operating temperature max.	85 °C
Additional condition temperature range	depending on cable quality
Important installation notes	
Note on strain relief	Protect the connectors by suitable measures from mechanical loads, e.g. by the usage of cable ties.
Note on bending radius	<b>Attention:</b> Observe the permissible bending radii when laying cables, as the IP protection class can be endangered by excessive bending forces.
Conformity	
Product standard	DIN EN 61076-2-101 (M12)
Installation   Cable	
wire arrangement	brown, black, blue, white
Cable identification	234
Cable Type	3
Jacket Color	gray
Type of Certificate	cURus
Amount stranding	1
Stranding	4 wires twisted
wire arrangement	brown, black, blue, white
Cable weight	36,3 g/m
Material jacket	PUR
Shore hardness jacket	90 ± 5 Shore A
Freedom from ingredients (jacket)	lead-free, cadmium-free, CFC-free, halogen-free, silicone-free
Outer-diameter (jacket)	4,5 mm
Tolerance outer diameter (sheath)	± 5 %
Material wire insulation	PP
Amount wires	4
Outer diameter insulation	1,25 mm
Outer diameter tolerance core insulation	± 5 %
Shore hardness wire insulation	70 ± 5 Shore D
Ingredient freeness wire insulation	lead-free, cadmium-free, CFC-free, halogen-free, silicone-free
Amount strands (wire)	42

Diameter of single wires	0,1 mm
Conductor crosssection (wire)	0,34 mm <sup>2</sup>
Material conductor wire	Stranded copper wire, bare
Conductor type (wire)	strand class 6
Nominal voltage AC max.	300 V
Current load capacity (standard)	to DIN VDE 0298-4
Current load capacity min. wire	4,8 A
Electrical resistance line constant wire	57 Ω/km @ 20 °C
AC withstand voltage (wire - wire)	2,5 kV @ 60 s
Power frequency withstand voltage (wire - jacket)	2,5 kV @ 60 s
Min. operating temperature (static)	-40 °C
Max. operating temperature (fixed)	80 °C / 90 °C @ 10000 h Operation
Operating temperature min. (dynamic)	-25 °C
Operating temperature max. (dynamic)	80 °C / 90 °C @ 10000 h Operation
Flame resistance	IEC 60332-2-2   UL 1581 § 1090   UL 1581 § 1100 FT2
chemical resistance	Good, application-related testing
Gasoline resistance	Good, application-related testing
Oil resistance	Good, application-related testing   DIN EN 60811-404
Bending radius (fixed)	5 x Outer diameter
Bending radius (dynamic)	10 x Outer diameter
No. of bending cycles (C-track)	10 Mio. @ 25 °C
Traversing distance (C-track)	10 m @ 25 °C   horizontal
Travel speed (C-track)	3 m/s @ 25 °C
No. of torsion cycles	2 Mio.
Torsion stress	± 180 °/m
Torsion speed	35 cycles/min