

Modlink MSDD-set: Frame 4000-68123-0000000,
insert 4000-68000-0020000 + 4000-68000-0400000

Ürün Linki

örnekleme

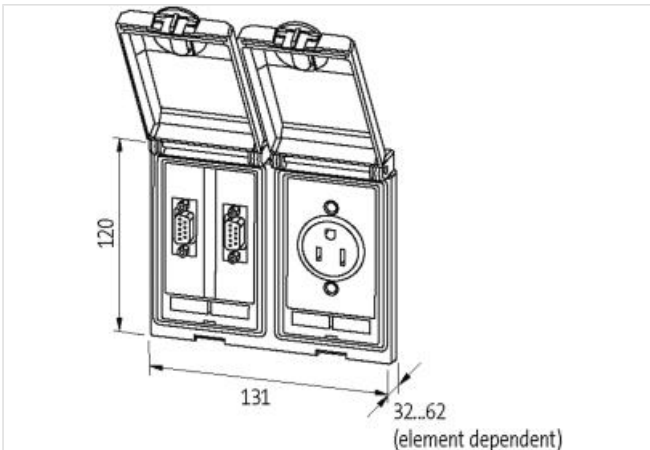

Ürün Image farklı olabilir

**Ticari bilgiler**

ECLASS-6.0	27189217
ECLASS-6.1	27189217
ECLASS-7.0	27189217
ECLASS-8.0	27189217
ECLASS-9.0	27189217
ECLASS-10.1	27182806
ECLASS-11.1	27182806
ECLASS-12.0	27182806
ETIM-5.0	EC002625
GTIN	4048879034913
Gümrük tarife no (gtip)	85366990
Paket miktarı	1

Frame

Degree of protection (EN IEC 60529)	IP65
Operating temperature min.	-10 °C
Operating temperature max.	60 °C
Storage temperature min.	-25 °C
Storage temperature max.	60 °C
Suitable for installation wall thickness min.	1 mm
Suitable for installation wall thickness max.	5 mm
Coating housing	surface finished
Material housing	Fine zinc die casting

Germany (VDE)

Connection cross section max.	6 mm ²
AWG number max.	10
Operating voltage AC	250 V
Operating current	16 A
Connection	Screw terminals SK
No. of poles	2 + PE
Connections per pole	2
Protection contact present	yes

SUB-D9

Operating voltage AC	48 V
Operating voltage DC	48 V
Operating voltage AC max. (UL-listed)	30 V
Operating voltage DC max. (UL-listed)	42,4 V
Operating current	3 A
Current operating max. (UL)	175 mA
Family construction form	SUB-D9
Family type Back side	SUB-D9
Gender	female
Gender Rear	male
Looking techniques	Standard UNC 4-40 screw thread bolt (EN 60807)
No. of poles	9

SUB-D25

Operating voltage AC	48 V
----------------------	------

Operating voltage DC	48 V
Operating voltage AC max. (UL-listed)	30 V
Operating voltage DC max. (UL-listed)	42,4 V
Operating current	3 A
Current operating max. (UL)	175 mA
Family construction form	SUB-D25
Family type Back side	SUB-D25
Gender	female
Gender Rear	male
Looking techniques	Standard UNC 4-40 screw thread bolt (EN 60807)
No. of poles	25